

E9-2003-65

N. A. Morozov, H. J. Schreiber*

**MAGNETIC FIELD CALCULATIONS
FOR THE TECHNICAL PROPOSAL
OF THE TESLA SPECTROMETER MAGNET**

*DESY, Zeuthen, Germany

Introduction

The Tera Electron volts Superconducting Linear Accelerator (TESLA) is an electron/positron linear collider, with an energy of 250 GeV per beam, under consideration at the Deutsches Elektronen Synchrotron (DESY) [1]. The measurement of the top quark mass with an error of less than 100MeV (which is comparable to the error resulting from theory) requires the knowledge of the beam energy of both beams (e^+ and e^-) with a precision of $\Delta E/E \leq 10^{-4}$. Two different designs were proposed [2] for an energy measuring device, a magnetic spectrometer and a setup which makes use of Moller scattering. The present report describes calculations for the preliminary conceptual design of the magnetic spectrometer.

Requirements

Magnetic spectrometers with energy resolutions of a few times 10^{-4} have been used for precision energy measurement at LEP [3, 4, 5, 6] and SLC [7, 8, 9]. The reference magnet to spectrometer quality has been used at ARC project CEBAF [10, 11, 12] to measure the absolute beam energy with the same resolution. In [2] a design similar to the LEP spectrometer (Fig.1) was proposed. The setup for TESLA should consist of a magnetic chicane of two deflection magnets and one spectrometer magnet. The field integral of the spectrometer magnet has to be mapped to a resolution of $\Delta|Bdl|/|Bdl| \leq 3 \times 10^{-5}$ in the beam energy region $E = (45 - 400)$ GeV. The deflection angle in the spectrometer magnet has to be 1 mrad, in ancillary ones – 0.5 mrad. As prototype magnets, the magnets of SLC, LEP and CEBAF have been considered. Their basic parameters are collected in Table 1.

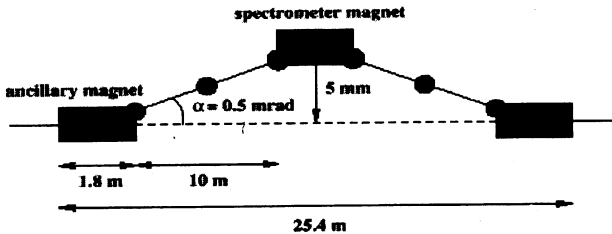

Fig.1. TESLA magnetic spectrometer

Choice of the spectrometer magnet length, gap and yoke shape

Using the formula for the small deflection angle (θ) in the bending magnet ($|B \bullet dl| = B_0 \bullet L_{\text{mag}}$) for the relativistic particles with the energy E :

$$\theta \text{ (mrad)} = 299.792 B_0 \text{ (T)} \bullet L_{\text{mag}} \text{ (m)} / E \text{ (GeV)} \quad (1)$$

it is possible to produce the set of curves $B_0 = f(L_{\text{mag}})$. This set is presented in Fig.2 for the boundary beam energies $E = 45$ and 400 GeV. In this figure the working magnetic field ranges for the SLC, LEP and CEBAF spectrometer magnets and for the METROLAB NMR Teslameter probes [13] are presented too.

Table 1. Basic spectrometers magnet parameters

	SLC	LEP	CEBAF	TESLA (Proposal)
Energy E (GeV)	42 - 50	40 - 100	0.5 - 7	45 - 400
Absolute accuracy of energy measurement $\Delta E/E$	5×10^{-4}	1×10^{-4}	1×10^{-4}	1×10^{-4} - 1×10^{-5}
Bending angle (mrad)	18.286	3.75		1
Magnetic field range (T)	0.88 - 1.1	0.086 - 0.216	0.04 - 0.6	0.05 - 0.44
Magnetic field integral (T·m)	2.56 - 3.05	0.5 - 1.242	0.12 - 1.8	0.15 - 1.33
Magnetic measurement error of the field integral (relative)	7×10^{-5}	3×10^{-5}	1×10^{-5}	$(1 - 3) \times 10^{-5}$
Magnet iron length (m)	2.5	5.75	3	3
Effective magnet length (m)				3.045
Gap height (mm)	31.7	100	25.4	35
Magnet type	H	C	C	C
Laboratory $\int B \cdot dl$ measurement technique	Moving wire, moving probe (NMR, Hall)	Moving probe (NMR, Hall), search coil	NMR probe, 2 search coils	Should be estimated
Operational $\int B \cdot dl$ measurement technique	Flip coil, fixed probes (NMR)	Fixed probes (NMR)		Should be estimated
Energy loss due to synchrotron radiation (max) (MeV)		3.55		120

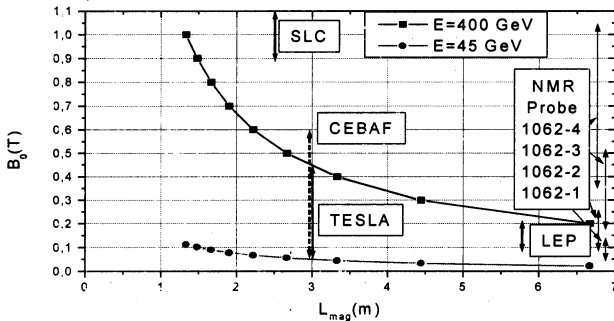

Fig.2. $B_0=f(L_{\text{mag}})$ relations for the TESLA spectrometer magnet

As for the METROLAB 1062-1 NMR probe, the minimal detectable magnetic field is 0.043 T, the magnet length should be less then or to equal 3 m. Among the main points against reduction of the magnet length there are:

- an increase in the synchrotron radiation power loss (Fig.3),
- an increasing fraction of the fringe magnetic field integral in the general field integral (Fig.4) (poorer accuracy of the field integral measurement).

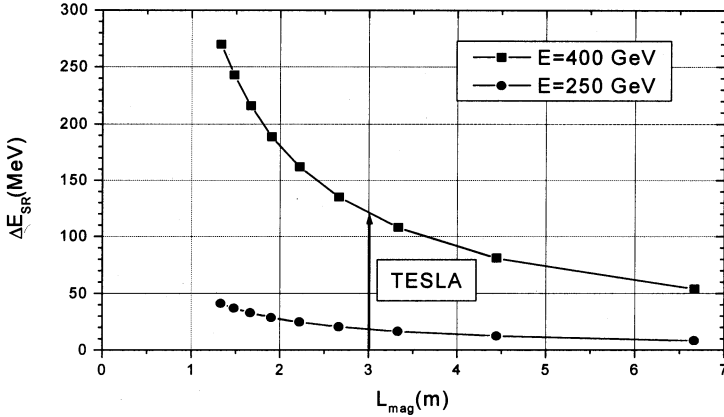

Fig.3. Energy loss due to synchrotron radiation in the TESLA spectrometer magnet for the beam energy $E=250$ and 400 GeV

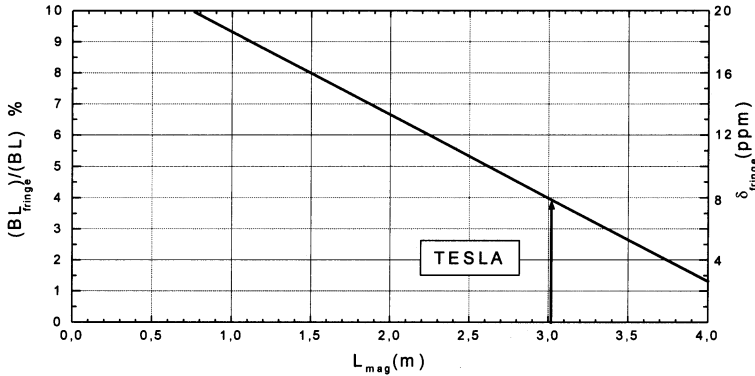

Fig.4. Fraction of the fringe field integral and the relative accuracy of the fringe field measurement by the Hall probe

The dependence presented in Fig.4 was calculated under the assumption that the fringe magnetic field was measured by the Hall probe with an accuracy of 200 ppm and the fringe integral fraction was 4% for the magnet length of 3 m.

Other arguments against the decreasing magnet length are:

- an increase in the required maximum level of the magnetic field in the pole gap (the magnet coil power dissipation increases to provide the yoke temperature stability is more difficult),
- an increase in the magnet field working range (the influence of nonlinear effects in the structure of the field grows).

In view of all these circumstances the length of the spectrometer magnet was chosen to be 3 m. To that length corresponds the working range of the magnetic field 0.05 - 0.44 T. This range may be measured by three types of METROLAB NMR probes (1062-1, 1062-2, 1062-3). The dependence of the magnetic field on the beam energy is shown in Fig.5. The main reference spectrometer energies are given in this figure.

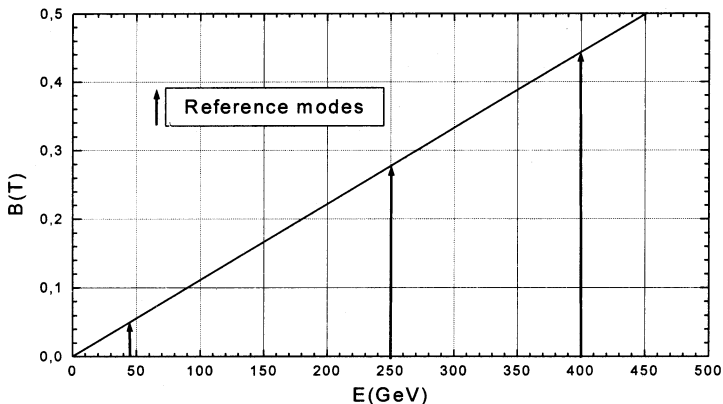

Fig.5. Working line of the TESLA spectrometer magnet

In deciding on the magnet yoke shape the preference was given to the C-type, as at the magnet length of 3 m it allows an easy access to the pole gap for installation and manipulation of the vacuum chamber and magnetic field measurement equipment.

When estimating the pole gap, we took into account the possibility of installing a $\varnothing 20$ mm vacuum chamber, an NMR probe, and a traveling stage with moving wire for magnet calibration during energy measurements. The magnetic field measurement probes are arranged along the measured electron beam for the better accuracy. This yields the required pole gap of 35 mm. The equipment layout is schematically presented in Fig.6. The vacuum chamber is centered along the beam axis when the spectrometer magnet is switched off. If the spectrometer is switched on, the beam

center is displaced by 5 mm from the chamber axis (for the middle cross section of the magnet). The proposed TESLA spectrometer magnet parameters are included in Table 1.

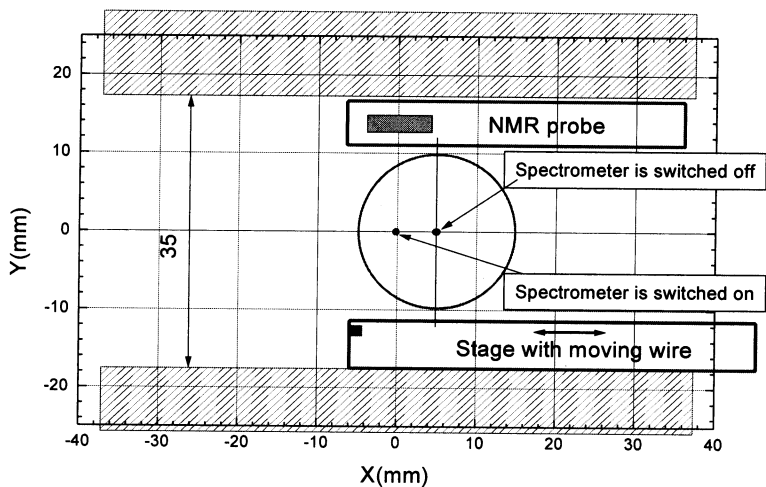

Fig.6. Cross-sectional view of the spectrometer magnet pole gap

Computer models

Magnetic field calculations for the spectrometer magnet were done by means of the 2D magnetostatic computer code POISSON SUPERFISH [14]. Three models were generated:

- Model 1 represents the middle section of the magnet (1/2 part) in the X-Y plane (Fig.7). This model was used for the magnetic field calculation in the transverse (X) direction of the pole gap.
- Model 2 includes a full cross-section of the spectrometer magnet in the X-Y plane. This model was used for the calculation of asymmetry effects in the median magnet plane.
- Model 3 represents the longitudinal section of the magnet (through the magnet pole axis) in the Z-Y plane (Fig.7). The section of the pole goes only 200 mm deep (out of 3000 mm full length). For short-circuiting of the magnetic flux a special effective yoke was included in the model. This model was used for the fringe magnetic field calculation in the longitudinal (Z) direction of the pole gap.

The models are presented in Fig.8-10.

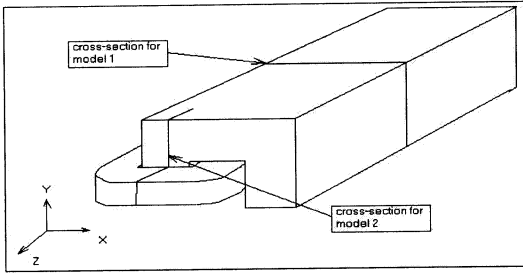

Fig.7. 3D view of the spectrometer magnet (1/2 part). Cross-sections for the 2D POISSON models are shown

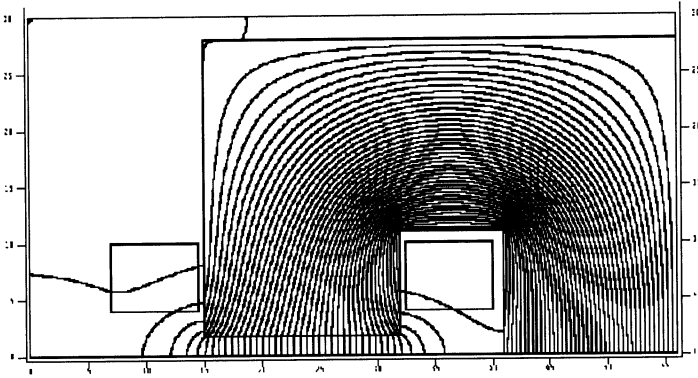

Fig.8. POISSON SUPERFISH model 1 showing magnetic flux lines

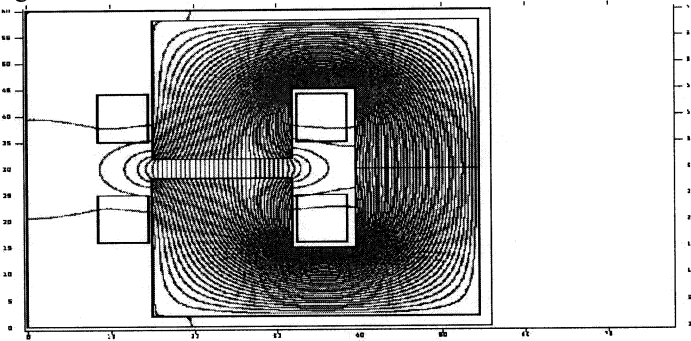

Fig.9. Model 2

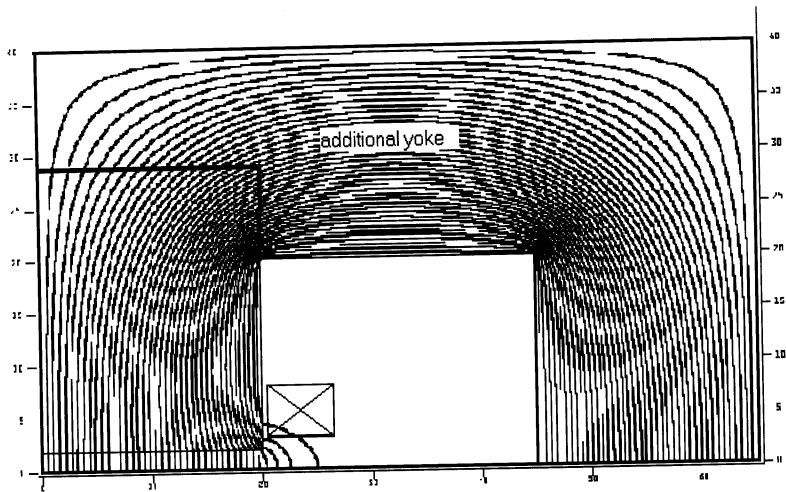

Fig.10. POISSON SUPERFISH model 3 showing magnetic flux lines

Magnetic field calculations and basic spectrometer magnet parameters

To choose the basic magnet parameters, calculations by model 1 were performed. During the calculations the yoke shape was optimized to meet the requirement of having the magnetic field uniformity region within the relative boundaries ± 10 ppm. The cross section of the optimized magnet yoke is shown in Fig.11 and its full 3D view in Fig.12. The excitation curve for the magnet is presented in Fig.13. Figure 14 displays the relative difference between the excitation curves with and without ($\mu_{Fe}=\infty$) saturation effects. These calculations yield the A*turn range for the spectrometer magnet of 700 – 6335 (per pole).

Figure 15 presents the magnetic field distributions in the X direction of the spectrometer magnet for the reference electron beam energy are presented, Fig.16 shows the normalized ones. The relative magnetic field uniformity 10 ppm exists for the working range in the horizontal magnet aperture ± 9.5 mm.

The conductor type for the magnet coils and the maximal conductor current density were chosen to provide the growth of temperature of the coils within the limits about one degree. It will allow to reduce to the minimum the temperature effects of magnet coils and yoke for the spectrometer magnetic field. The parameters of the magnet are in Table 2.

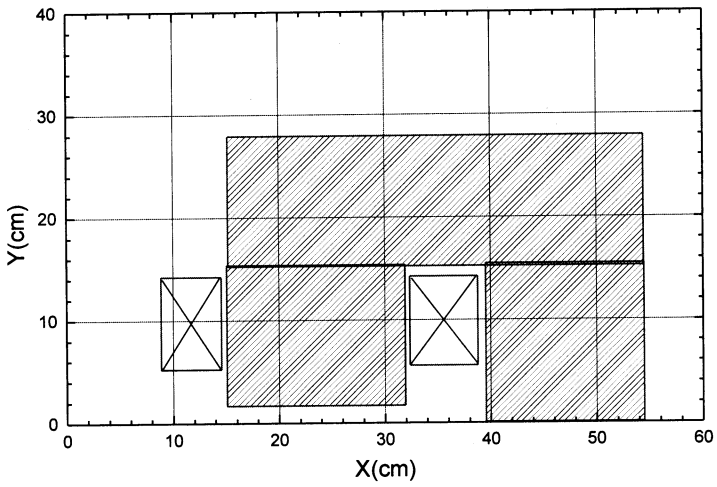

Fig.11. Cross-sectional view of the optimized geometry of the TESLA spectrometer magnet

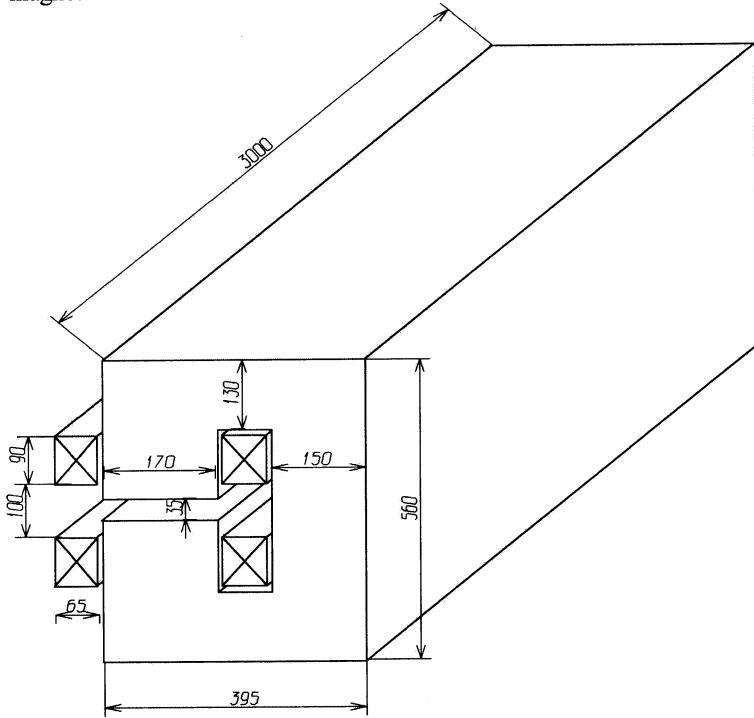

Fig.12. 3D view of the spectrometer magnet (dimensions are in mm)

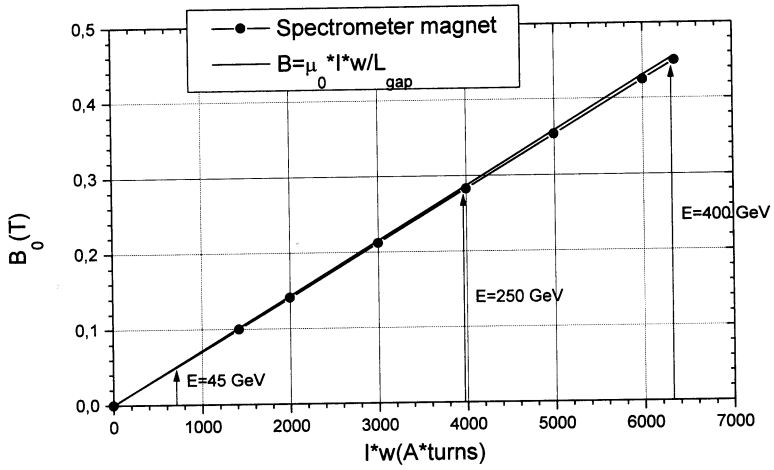

Fig.13.Excitation curve for the spectrometer magnet and the line for the magnet with $\mu_{Fe} = \infty$

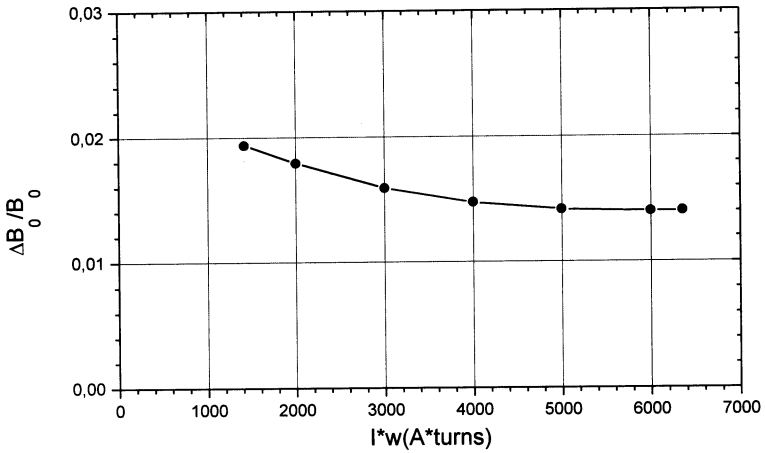

Fig.14. Effect of saturation for the spectrometer magnet

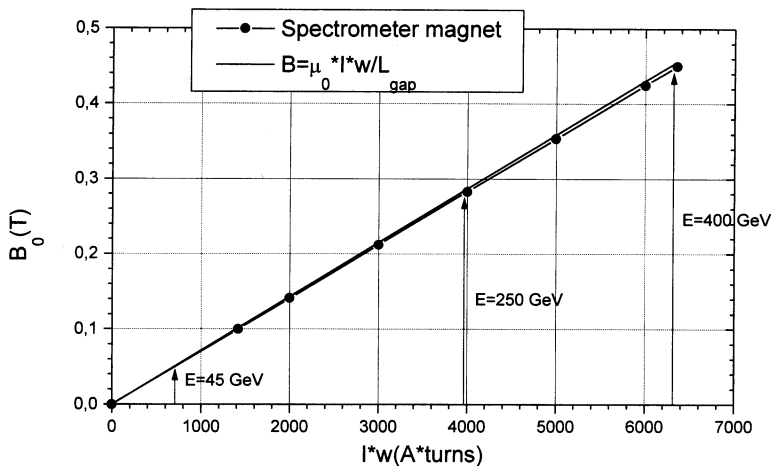

Fig.13.Excitation curve for the spectrometer magnet and the line for the magnet with $\mu_{Fe} = \infty$

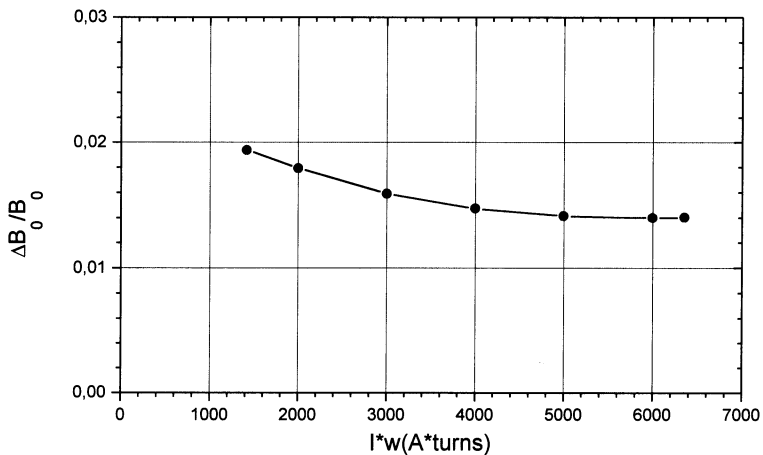

Fig.14. Effect of saturation for the spectrometer magnet

Table 2. Basic technical parameters of the TESLA spectrometer magnet (optimized geometry)

Magnetic field (min/max) (T)	0.05/0.44
Pole gap (mm)	35
Yoke type	C
Yoke dimensions (mm)	395×560×3000
Yoke weight (t)	4.51
A*turns (1 coil) (max)	6335
Number of turns (1 coil)	6*4=24
Conductor type	Cu, 12.5×12.5, Ø7.5
Coil current (max) (A)	264
Current density (max) (A/mm ²)	2.4
Coil voltage (max) (V)	13.3
Coils power dissipation (max) (kW)	3.5
Number of water cooling loops	6
Length of cooling loop (m)	56
Water input pressure (Bar)	6
Water input temperature (deg C)	30
Temperature rise (deg C)	1.4

POISSON model 3 was used for calculation of the fringe magnet field in the longitudinal direction and the effective magnet length. In Fig.17 the magnetic field distributions in the Z direction of the magnet are presented.

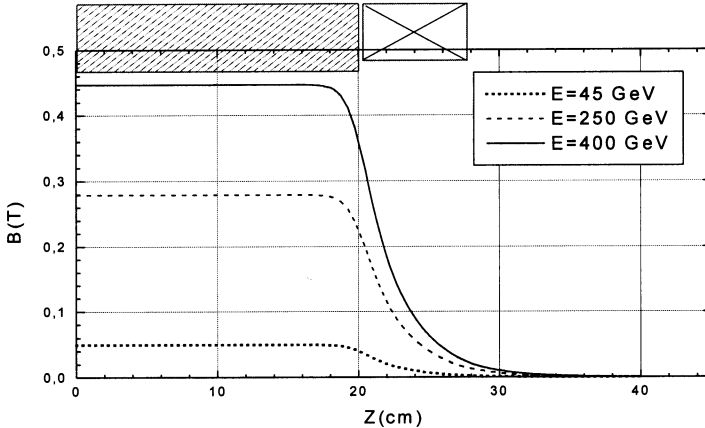

Fig.17. Magnetic field distribution in the Z direction of the spectrometer magnet

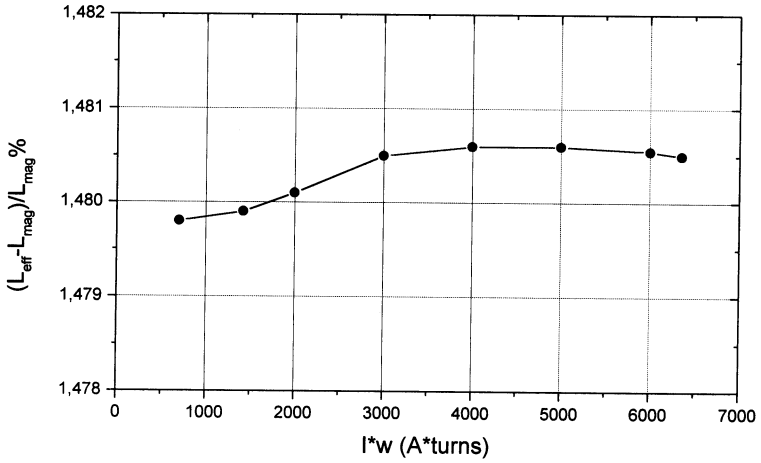

Fig.18. Normalized effective length of the spectrometer magnet

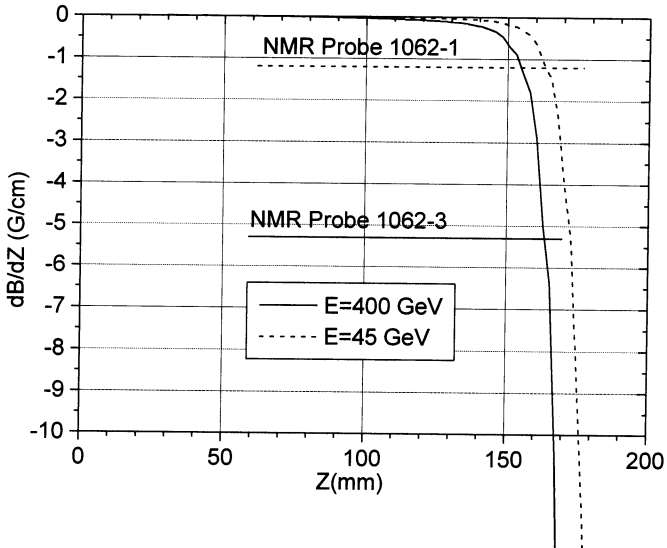

Fig.19. Magnetic field gradient distribution in the Z direction.

Variation of the magnet effective length over the working range of the magnet is shown in Fig.18. The calculations of the longitudinal magnetic field made it possible to determine the region of using the NMR probes during the measurements of the field. According to the technical specification for the METROLAB NMR probes [13], the probes 1062-1, 2 and 3 work in the magnetic field with uniformity < 1200 ppm/cm. Figure 19 presents the magnetic field gradient and the ultimate gradient line for NMR probes. The crosses of the associated lines estimate that the NMR probes have the working region up to 40 mm from the pole edge. This means that it will be possible to measure 96% of the whole magnetic field integral with the NMR probes.

Conclusions

The 2D calculations of the magnetic field for the TESLA spectrometer magnet have been performed. The basic technical parameters of the spectrometer magnet have been determined. These data will serve as of basis for the technical design of the magnet and discuss of its integration in the spectrometer.

References

- 1) TESLA Technical Design Report, DESY TESLA-01-23, 2001.
- 2) Ibid, Part IV, pp.143 – 146.
- 3) Dehning B. - Status of the LEP2 Spectrometer Project. In Proceedings of EPAC 2000 , Vienna, Austria, 2000.
- 4) Roncarolo F. et al. - High Accuracy Field Mappings with a Laser Monitored Travelling Mole. In Proceedings of EPAC 2000 , Vienna, Austria, 2000.
- 5) Prochnow J. - The LEP Energy Spectrometer. Diplomarbeit in Physik, 2000.
- 6) Roncarolo F. - High Accuracy Magnetic Field Mapping of the LEP Spectrometer Magnet The thesis work, Academic Year 1999-2000.
- 7) Kent J. et al. - Precision Measurements of the SLC Beam Energy. SLAC-PUB-4922, LBL-26977 , 1989.
- 8) Watson S. et al. - Precision Measurements of the SLC Reference Magnets. SLAC-PUB-4908, LBL-26956, 1989.
- 9) Levi M. et al. - Precision Measurements of the SLC Spectrometer Magnets. SLAC-PUB-4654, 1989.
- 10) Gougnaud F. et al. - Controls for High Precision Beam Energy Determination at CEBAF, HALL A: The ARC Project. ICA LEPCS, 1999, Trieste, Italy.
- 11) Kircher F. et al. - Reference dipole measurement for CEBAF beam energy determination.. Proc. of MT-15 Conference, 1279-1282, Beijing, China, 1997.
- 12) Kircher F. et al. - High Accuracy Field Integral measurement for CEBAF Beam Energy determination.. Proc. of MT-16 Conference, Jacksonville, Florida, USA, 1999.
- 13) METROLAB Instruments SA, PT 2025 NMR Teslameter, Probes type 1062.
<http://www.metrolab.com>.
- 14) Billen J.H., Young L.M. - POISSON SUPPERFISH Documentation, LA-UR-96-1834.

Received on April 9, 2003.

Морозов Н. А., Шрайбер Х. Ю.

E9-2003-65

Расчеты магнитного поля для технического предложения
магнита спектрометра TESLA

Рассматривается проект электронно-позитронного линейного коллайдера TESLA (DESY, Гамбург). Реализация физической программы на этом коллайдере требует знания энергии обоих пучков (e^+ и e^-) с точностью $\Delta E/E \leq 10^{-4}$. В качестве устройства измерения энергии предложен магнитный спектрометр. Описаны расчеты по предварительному выбору концепции спектрометра этого типа. Двухмерные расчеты магнитного поля для магнита спектрометра были проведены при помощи компьютерной программы POISSON SUPERFISH. Были определены основные технические параметры магнита. Эти данные составят основу для технического проектирования магнита спектрометра и изучения его интегрирования в конструкцию спектрометра.

Работа выполнена в Лаборатории ядерных проблем им. В. П. Дзелепова ОИЯИ.

Сообщение Объединенного института ядерных исследований. Дубна, 2003

Morozov N. A., Schreiber H. J.

E9-2003-65

Magnetic Field Calculations for the Technical Proposal of the
TESLA Spectrometer Magnet

The TESLA electron-positron linear collider is under consideration at DESY (Hamburg). The realization of the physical program at this collider requires the knowledge of the beam energy of both beams (e^+ and e^-) with a precision of $\Delta E/E \leq 10^{-4}$. The magnetic spectrometer was proposed as an energy measuring device. The report describes calculations for the preliminary conceptual design of this type of spectrometer. The 2D calculations of the magnetic field for the spectrometer magnet have been performed by POISSON SUPERFISH computer code. The basic technical parameters of the magnet have been determined. These data will serve as a basis for the technical design of the spectrometer magnet and discuss its integration in the spectrometer.

The investigation has been performed at the Dzhelepov Laboratory of Nuclear Problems, JINR.

Communication of the Joint Institute for Nuclear Research. Dubna, 2003

Макет Т. Е. Попеко

Подписано в печать 15.05.2003.

Формат 60 × 90/16. Бумага офсетная. Печать офсетная.

Усл. печ. л. 1,0. Уч.-изд. л. 1,54. Тираж 270 экз. Заказ № 53892.

Издательский отдел Объединенного института ядерных исследований
141980, г. Дубна, Московская обл., ул. Жолио-Кюри, 6.

E-mail: publish@pds.jinr.ru

www.jinr.ru/publish/