

E1-2011-24

A. Baldin, E. Belov¹, V. Chilap¹, A. Chinenov¹,
V. Furman, M. Galanin¹, N. Gundorin,
M. Kadykov, V. Kolesnikov¹, S. Korneev²,
A. Khilmanovich³, B. Martsynkevich³, A. Rogov,
N. Ryazansky¹, S. Solodchenkova¹, V. N. Sorokin²,
V. V. Sorokin², S. Tyutyunnikov

**RELATIVISTIC NUCLEAR TECHNOLOGY (RNT)
FOR ENERGY PRODUCTION AND UTILIZATION
OF SPENT NUCLEAR FUEL.
THE RESULTS OF FIRST EXPERIMENTS
ON PHYSICAL JUSTIFICATION OF RNT**

Submitted to «Письма в ЭЧАЯ»

¹Center of Physic and Technical Projects «Atomenergomash», Moscow

²Joint Institute for Power and Nuclear Research – Sosny, Minsk

³Stepanov Physics Institute, Minsk

Балдин А. А. и др.

E1-2011-24

Ядерные релятивистские технологии (ЯРТ) для производства энергии и утилизации отработанного ядерного топлива. Результаты первых экспериментов по физическому обоснованию ЯРТ

Обсуждается принципиально новая схема электроядерного метода, основанная на ядерных релятивистских технологиях (ЯРТ), которые предусматривают формирование и использование предельно жесткого нейтронного спектра в объеме глубокоподкритической активной зоны. Показано, что развитие и применение ЯРТ может быть перспективным для решения проблемы утилизации отработанного ядерного топлива и глобальных задач энергетики. Результаты первых экспериментов, проведенных в ОИЯИ, указывают на реалистичность основных принципов ЯРТ, в частности, на двукратный рост коэффициента усиления мощности пучка дейтронов, облучающих массивную (315 кг) урановую мишень, при увеличении энергии пучка от 1 до 4 ГэВ.

Работа выполнена в Лаборатории физики высоких энергий им. В. И. Векслера и А. М. Балдина ОИЯИ.

Препринт Объединенного института ядерных исследований. Дубна, 2011

Baldin A. et al.

E1-2011-24

Relativistic Nuclear Technology (RNT) for Energy Production and Utilization of Spent Nuclear Fuel. The Results of First Experiments on Physical Justification of RNT

An essentially new scheme of the electronuclear method — relativistic nuclear technology (RNT) — is considered. This is based on the use of the neutron spectrum forming in the deep subcritical active core, much harder than created in chain fission process. It is shown that an application of RNT for utilization of the radioactive nuclear wastes and energy production seems to be very promising. The results of the first experiments carried out at JINR demonstrate the validity of basic principles of RNT. In particular, these point to the essential (twofold) growth of beam power gain in massive (315 kg) uranium target irradiated with deuterons with increasing energy from 1 to 4 GeV.

The investigation has been performed at the Veksler and Baldin Laboratory of High Energy Physics, JINR.

Preprint of the Joint Institute for Nuclear Research. Dubna, 2011

INTRODUCTION

Global energy challenges of the 21st century cannot be solved without the use of nuclear energy. However, the main fuel of modern nuclear energy, ^{235}U , is in the energy equivalent of no more than oil and gas [1–3]. Large reserves of natural uranium (^{238}U — 99.3% and ^{235}U — 0.7%) and thorium can ensure the future of energy, but in the present and even future reactors they practically do not «burn» because of the high fission threshold ($\sim 1\text{--}2$ MeV).

Fast and thermal reactors operate at a controlled fission chain reaction with mean neutron energy about or substantially below 0.2 MeV. Subcritical multiplying systems, initiated by accelerators (electronuclear system or Accelerator Driven Systems, ADS), can in principle work with much harder neutron spectrum. However, the vast majority of ADS schemes proposed [4] use the same «reactor» neutron spectrum, implemented in subcritical systems with a $k_{\text{eff}} \sim 0.94\text{--}0.98$.

Analysis of the various areas of nuclear power [5] shows limitations of the capabilities of traditional reactors in addressing global energy challenges. Due to great recent progress in design and manufacture of powerful high-energy accelerators, ADS could become competitive in solving of future energy problems.

The present paper discusses a new electronuclear scheme based on the relativistic nuclear technologies (RNT) [6], as well as first results of experiments performed at JINR in order to verify the prospects of the basic principles of RNT. This scheme is aimed at creation of extremely hard neutron spectrum inside of the multiplying system. It is expected that such a spectrum would permit one to «burn» for energy production natural (depleted) uranium or thorium and simultaneously utilize the long-lived components of spent nuclear fuel (SNF) of nuclear power plants.

Relativistic nuclear technology [5, 6] is based on the implementation of the following basic principles.

1. *Using the deep subcritical active core (AC) of natural (depleted) uranium or thorium the size of which provides minimal leakage of neutrons. (Below this core is called the quasi-infinite.)*
2. *An increase in the energy of incident particles up to ~ 10 GeV instead of 1 GeV as in the traditional ADS schemes.*
3. *Using as a target for incident beam the material of AC.*
4. *Application as a load of AC encapsulated fuel elements from uranium or thorium, as well as spent nuclear fuel, without its preliminary radiochemical reprocessing.*
5. *Using the technology of high-temperature helium coolant for primary circuit.*

The quasi-infinite active cores from natural uranium (thorium) were proposed to use in a number of studies on electronuclear breeding (see [2]). These AC are deeply subcritical. As long ago as 1958 it was shown [7] that only in a deep subcritical multiplying system it is possible to obtain the neutron spectrum determined by an external neutron source, i.e., to get substantially harder spectrum than one created by chain fission reaction.

By using the RNT scheme, an external source of high-energy neutrons born in the intranuclear cascade chain going in AC under the influence of the incident relativistic particles leads to the formation inside the quasi-infinite multiplying system of a powerful flux of hard neutrons, not directly related to fission neutrons of the system material.

So unlike traditional reactor and ADS scheme, the neutron spectrum in the AC volume is determined by a large set of competing inelastic processes, in particular, by multistep cascade reactions, as well as by threshold (n, xn) reactions. The hardest part of the neutron spectrum is formed by high-energy neutrons generated at first stages of intranuclear cascades. The obtained neutron spectrum allows «burning» out the AC material and the minor actinides placed in this system.

The soft part of the neutron spectrum (with energies below 1 MeV), which is formed by prompt fission neutrons and the above-mentioned inelastic processes, will cause the production of low concentrations of ^{239}Pu (^{233}U). This, as will be shown below, must lead to the substantially increased opportunities of RNT in energy production.

A significant increase in the energy of incident particles allows one to reduce by an order the required current of the accelerator at the same beam power and greatly increase [8] fraction of the energy beam, which goes to generate hard neutron field in the AC. This is determined in particular by the increasing role of meson production in growth of neutron multiplicity and the hardness of the neutron spectrum with increasing beam energy in quasi-infinite multiplying system.

Deep subcritical AC in the RNT scheme allows an order of magnitude lower power density in the central region, which serves as neutron production target through the use of divergent beam scanning. The latter, together with the reduction of beam current, leads to a substantial simplification of the problem of input beam window in AC.

1. PHYSICAL GROUNDS OF RNT

Table 1 shows the results of experiments [9] carried out on quasi-infinite homogeneous targets of mass ~ 3.5 tons of depleted and natural uranium, which were irradiated with protons at energies up to 660 MeV of the JINR synchrocyclotron. Due to the original idea of an asymmetric input beam, these results are

Table 1. The plutonium yield and the number of fissions in the targets per one proton with an energy of 660 MeV

Target	Plutonium yield (number of nuclei)	Number of fissions
Depleted uranium	38 ± 4	13.7 ± 1.2
Natural uranium	46 ± 4	18.5 ± 1.7

equivalent to results for the axisymmetric target mass of ~ 7 t. According to the authors [9], it was not accounted for 3 or 4 fission events (per one proton) occurring in the cascade region of the central zone of the target with a diameter of 10 cm due to specific design of the experimental setup. Leakage of neutrons from a target on the author's estimates was ~ 10 –12%.

In each fission event of ^{238}U nucleus, taking into account the energy of prompt neutrons, a total energy release is about 197 MeV. Since protons with an energy of 660 MeV are almost completely absorbed in the investigated targets, then adding three fission events occurring in the central region of the target, we find that the total energy release per proton is ~ 3950 MeV in depleted uranium and ~ 4900 MeV in natural uranium. Thus, the beam power gain (BPG) for protons with an energy of 660 MeV in this experiment, where an extremely hard neutron spectrum has been realized, amounted to ~ 6.0 and ~ 7.4 for depleted and natural uranium, respectively.

In works [10–12] performed at JINR, the dynamics of ^{239}Pu and ^{233}U production in quasi-infinite targets of natural uranium and thorium was theoretically investigated. In particular, it was found that in the thorium target irradiated by intense beam of protons with energies of 1 GeV, the rate of ^{233}U breeding is maximal up to its concentration $\leq 1.5\%$. With further increase in concentration this rate is reduced, and at a level of 6% a balance is achieved between the formation and disappearance of ^{233}U nuclei due to its fission and radioactive capture.

Taking into account that the ratios $\alpha = \sigma_\gamma / \sigma_f$ for ^{233}U and ^{239}Pu , as well as the radiation capture cross sections σ_γ for ^{232}Th and ^{238}U , are close for the considered characteristics of the neutron spectra [13], it is possible to take the value of $\sim 6\%$ obtained for the thorium AC as an estimation of the equilibrium concentration of ^{239}Pu in the quasi-infinite uranium AC.

Note that in [14] ADS with massive targets of natural and depleted uranium AC was investigated for incident protons with energies of 1 GeV. In particular, the calculations of the equilibrium concentration of ^{239}Pu and dynamics of its production were done. To find the neutron field $\Phi(r, z)$, the authors used a single-group diffusion approximation under the condition of a stationary incident beam and isotropic external source of neutrons. Of the many channels of hadronic processes of primary and secondary intranuclear cascades, only the fission of uranium AC by protons was taken into account. In addition, the calculations

were not entirely consistent; namely, the neutron spectrum implemented in fast reactors with an average neutron energy of about 0.2 MeV was used. The result was an estimate of the equilibrium concentration of ^{239}Pu at a level of 12%. It seems that the results of [10–12] give a more realistic estimate of the equilibrium concentration than in [14].

In [11, 12] a dependence of total energy release on the concentration of ^{239}Pu and ^{233}U in natural uranium and thorium targets, respectively, was studied. It was obtained that increase in the concentration of ^{233}U nuclei in the thorium target from zero to 6% leads to an increase in gain power of 1 GeV proton beam from 6 to 12 times [12]. An important result of [10, 12] is that in the investigated range (0–6%) concentrations of ^{239}Pu and ^{233}U revealed a very weak dependence of the main (hard) part of the neutron spectrum on the enrichment of deeply subcritical AC specified easily fissile isotopes. This allows one to keep the deep subcriticality of the RNT system at its reaching the equilibrium concentration of easily fissile isotopes. For comparison, recall that the traditional fast reactors operate at the fuel enrichment of 20% [15].

Table 2 shows the characteristics of neutron radiation depending on the energy of the incident protons for a massive lead target with dimensions $\text{Ø}20 \times 60$ cm, obtained in the work [16] performed at JINR.

Table 2. Energy characteristics of neutron radiation escaping from the limited-size lead target, depending on the incident proton energy

E_p , GeV	$\langle E \rangle$, MeV	E_{kin} , MeV	E_{kin}/E_p , %	W , MeV	W/E_p , %
0.994	8.82	213	21.3	382	38.2
2.0	11.6	513	25.6	822	41.1
3.65	13.7	1106	30.3	1670	45.6

Here, $\langle E \rangle$ is the average neutron energy, E_{kin} is the total kinetic energy of the neutron radiation, E_p is incident proton energy, W is part of proton energy spent on neutron production.

From the data of [9], we can estimate the ratio W/E_p for an incident proton energy of 660 MeV at a rate of 20%. As evident from [16], at $E_p \approx 1$ GeV this ratio increases to $\sim 38\%$, reaching at 3.65 GeV proton energy almost 46%. Extrapolation of this quantity to $E_p = 10$ GeV, based on calculations presented in [17], makes it possible to expect its value at around 60% (for details see [18]). Note that the increase in the ratio W/E_p can be largely linked to the increasing influence of meson production with growth of the incident proton energy.

Table 3 presents conservative estimates of the expected values of beam power gain (BPG) in quasi-infinite target of natural uranium in the energy dependence of the incident protons. These estimates are based on the results of [9] and the experimental data [16], as well as on calculations [11, 12] of an increase of

Table 3. The estimations of beam power gain for quasi-infinite natural uranium AC for different energy of incident protons

E_p , GeV	Start BPG	Equilibrium BPG_{eq}
0.66	~ 7.4	40–90
1.0	~ 12.0	70–140
10.0	~ 22.0	130–260

energy release in uranium AC at the equilibrium concentration of ^{239}Pu and on the balance approach [18].

The results shown in Table 3 are in formal contradiction with the conclusions of the experiment FEAT [19], performed at CERN with the multiplying target of natural uranium, the total mass of ~ 3.6 tons in the energy range of incident protons 0.6–2.75 GeV. For the energy $E_p = 0.6$ GeV was obtained $BPG \sim 20$, which is saturated (at $BPG \sim 30$) with increasing proton energy up to ~ 1 GeV. This result is apparently due to the construction of the multiplying target, made in a classic scheme of the heterogeneous thermal reactor, in which the cylinder assemblies of uranium rods are placed in a tank with ordinary (light) water. So in measurements [19], in contrary to experiment [9], the limiting case of a soft, almost thermal neutron spectrum with $k_{eff} \sim 0.9$ was realized.

Note that if, as evident from [19], the BPG reaches saturation in the energy range of 1.0–2.75 GeV, the full neutron yield per the energy unit with the growth of the beam energy in the studied range E_p , at least, does not reduce. Thus, the results of numerous model calculations, which indicate the reduction of this yield for > 1 GeV, are doubtful.

It must be mentioned that for the quantity BPG_{eq} , shown in the last column of Table 3, an important parameter that requires a special study is the time to reach equilibrium concentration of the isotope ^{239}Pu in AC after the start of ADS operation. This parameter is determined by the spectral characteristics of neutron fields in AC. According to estimates [11], a transition to the steady-state equilibrium concentration of ^{239}Pu can be expected through $\tau_{eq} \sim 0.5$ –1.0 years after the launch of ADS based on RNT. It is curious that the estimate of τ_{eq} obtained in [14] using rather simplified approach yields $\tau_{eq} \sim 1.5$ years, close to the result [11].

2. THE RESULTS OF THE FIRST EXPERIMENTS ON THE BASIC PHYSICS OF RNT

In June 2009, by initiative of CPTP «Atomenergomash», a series of experiments with the target assembly «Quinta» [20] irradiated with a deuteron beam from the JINR Nuclotron with energies of 1 and 4 GeV were carried out. This

assembly, shown in Fig. 1, consists of the uranium target placed in a lead blanket of thickness 10 cm with the input beam window size 150×150 mm. The target consists of three sections of hexagonal aluminum containers with an inscribed diameter of 284 mm, each of which contains 61 cylindrical uranium blocks. Blocks 36 mm in diameter and 104 mm in length are made of metallic natural uranium and placed in sealed aluminum housing. Unit weight is 1.72 kg and the total mass of uranium in one section is 104.92 kg. In front of the target and between its sections, as well as behind it, there are 4 detector probes.

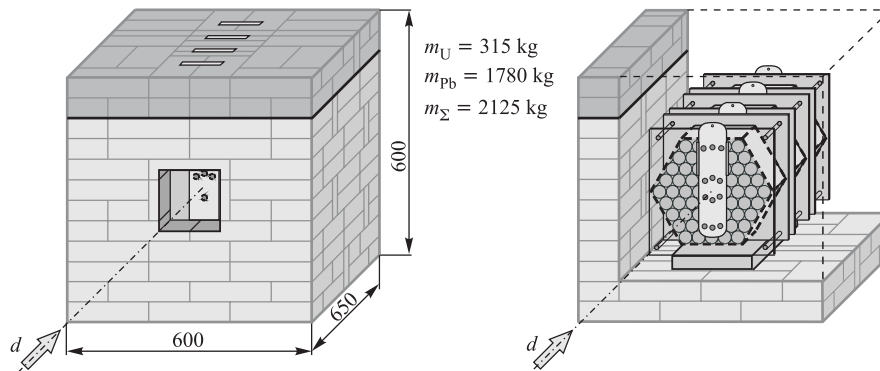

Fig. 1. Target assembly «Quinta»

For comparative experiments in the assembly there was also used a lead target, structurally identical to the uranium one.

The scheme of the experiment is shown in Fig. 2. In these experiments, for the first time in the study of accelerator driven systems, the integral characteristics of fission in AC were examined by measuring the time spectra of delayed neutrons (DN). They were recorded with a detector assembly «Isomer-M». It consists of 11 ^3He proportional counters (SNM-33 and SUI-44) mounted in a block of plexiglass moderator with dimensions $50 \times 50 \times 60$ cm.

Each neutron counter is equipped with a preamplifier and discriminator. More features of the detector, the DAQ system, and the technique used in these experiments are presented in [21]. Massive combined shielding of ^3He counters (CH-B-Cd) has provided the suppression of the neutron background to the level of 1.7% in the measurements with the uranium target at an energy of 4 GeV deuterons. The experimentally measured Isomer-M detection efficiency for neutrons from Pu–Be source with an average energy spectrum of 4.4 MeV was $(11.4 \pm 0.1)\%$. The result of modeling of the neutron count intensity from this source, performed with the use of computer code MCNPX v. 2.5 for the real

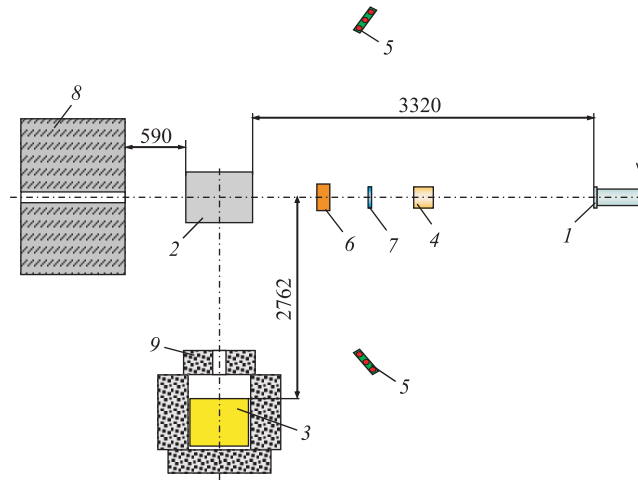

Fig. 2. The scheme of experiment: 1 — deuteron beam, 2 — target assembly «Quinta», 3 — detector of delayed neutrons «Isomer-M», 4–6 — on-line (7 — off-line) beam monitoring system, 8, 9 — shielding

geometry of the experiment gives $(4.77E-05 \pm 5E-07) \text{ s}^{-1}$, which is in good agreement with the measured value $(4.86E-05 \pm 3E-07) \text{ s}^{-1}$.

Besides, the scintillation neutron detector based on stilbene crystal of the sizes $\text{Ø}35 \text{ mm} \times 40 \text{ mm}$ and placed over detector «Isomer-M» was used in measurements of neutron yield.

Monitoring of beam intensity and its position on the target was performed by means of three independent systems:

- 1) on-line system measuring an intensity, time structure and position on the target of extracted beam in each accelerator burst realized on the basis of the ionization chamber, a profilometer and two scintillation telescopes;
- 2) off-line system obtaining the integral beam flux on the target by means of STD;
- 3) off-line system getting the integral beam intensity on the target with the aid of Al foil.

The results of three-system monitoring coincide in value of integral deuteron current within the error of 15% for all four energies.

Figure 3 shows the time dependence of neutron yield from a uranium target irradiated with deuterons with energies $E_d = 1$ and 4 GeV (indicated by 2 and 3, respectively), as well as from geometrically identical lead target for $E_d = 4$ GeV (labeled by 1). The incident deuteron beam (duration of pulse ~ 500 ms, repletion

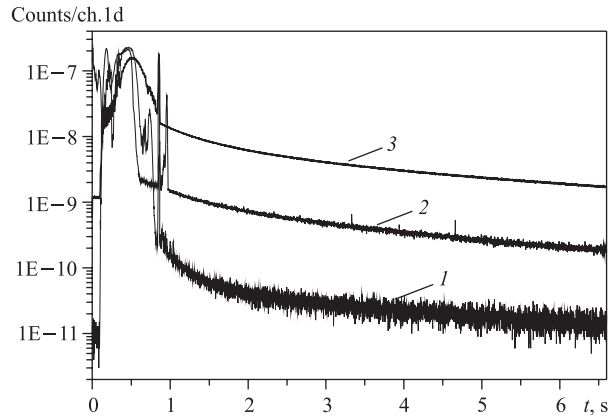

Fig. 3. The time dependence of the neutron yield from the geometrically identical lead and uranium targets: 1 — (Pb + d) for $E_d = 4$ GeV; 2 and 3 (U + d) for $E_d = 1$ and 4 GeV

rate $\sim 8-9$ s) had fine temporary structure defined by features of the beam extraction from the Nuclotron.

In the time interval from 0.9 till 7.6 s after the start of the deuteron pulse, the summed count of neutrons from the lead target is 0.84% on the corresponding count for the uranium target at the energy of deuterons 4 GeV. It is obvious that delayed neutrons from the lead target are related only with the yield of light radioactive fragments since the fission cross section of lead is extremely small [22]. Thus, most of DN in the assembly «Quinta» with uranium target are produced in fission of the uranium nuclei.

Analysis of the time spectra of DN presented in Fig.3 shows that with increasing deuteron energy from 1 to 4 GeV, the number of fissions and hence the total energy release in the uranium target increases (8.7 ± 1.2) and (10.3 ± 1.5) times the data obtained by the Isomer-M and stilbene detector, respectively. So, the beam power gain has to grow at least two times. Note that the error values given are determined mainly by the accuracy of monitoring the deuteron beam current.

In November 2009, at the Nuclotron a new experiment was carried out with the target set-up «Energy + Transmutation» («E + T») [23] irradiated with 4 GeV deuterons. The «E + T» set-up consists of a central lead target surrounded by 200 kg blanket from metallic natural uranium (see Fig.4). Beside that the lead-uranium assembly was placed in thick (~ 300 mm) and dense ($\rho = 0.7$ g/cm³) polyethylene box serving as a reflector and a moderator. In parallel with measurements made on the program of the collaboration «Energy plus Transmutation», measurements of the time dependence of neutron yields were performed. Figure

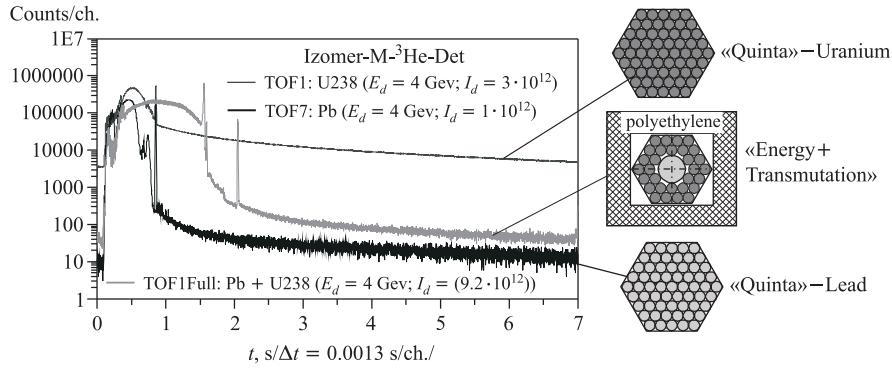

Fig. 4. The time dependence of neutron yields from different target assemblies for $E_d = 4$ GeV

4 shows the time dependence of neutron yields from the target set-ups «Quinta» and «E+T» obtained by the detector assembly «Isomer-M».

It is seen from Fig. 4 that at the same beam energy the DN yield and respectively the number of fissions in the «E + T» target assembly is approximately by 2 orders of magnitude smaller than for the «Quinta» one. This could be related with the use of the intermediate lead target in the set-up «E + T» and also with the small thickness of the uranium blanket. Besides, the presence of the thick layer of polyethylene surrounding the target assembly has to make a resulting neutron spectrum softer in comparison with the same for the «Quinta» set-up. All these factors could lead to decreasing of the number of fissions in the «E + T» set-up.

More detailed analysis of the DN time spectra allows one to obtain information on characteristics of precursors of delayed neutrons studied in our experiments. Due to specific conditions of the performed experiments (the narrow time window for detection of DN), it is possible to get information only for the short-lived precursor groups. The decomposition of the DN time spectra was made taking into account the groups with half-life 2.5 s (fifth group) and 0.6 s (the sum of 6th and 7th ones from 8-group decomposition). For more detail of the decomposition method, see [20].

In Fig. 5 the systematics of weight ratios [23–27] of the above-mentioned groups in dependence on neutron energy for $^{238}\text{U}(n, f)$ reaction is presented together with the respective ratios (horizontal lines with error corridors) extracted from analysis of the DN time spectra measured for the uranium target assembly «Quinta» at deuteron energies of 1 and 4 GeV, as well as for the $(\text{Pb} + ^{238}\text{U})$ assembly «E + T» at $E_d = 4$ GeV.

As evident from Fig. 5, for the uranium target assembly «Quinta» the values of the mean neutron energy $\langle E_n \rangle$ inducing ^{238}U fission are about 15 and 25 MeV

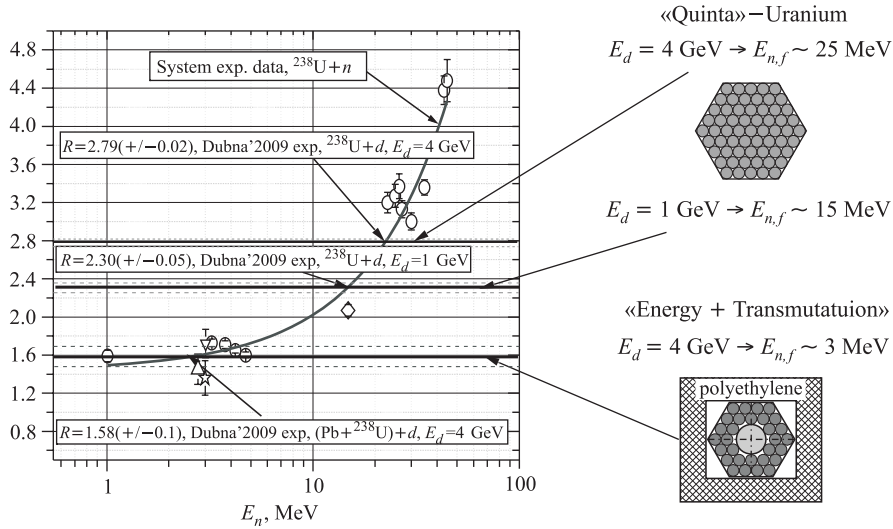

Fig. 5. Comparison of neutron energy dependence of the weight ratios of 5th to (6 + 7th) DN groups from $^{238}\text{U}(n, f)$ -reaction [24–28] and similar values extracted from DN time spectra measured in the present work

for $E_d = 1$ and 4 GeV, correspondingly. But for the «E + T» target assembly $\langle E_n \rangle$ is much lower and is only ~ 3 MeV at $E_d = 4$ GeV.

The DN decay spectra observed in our measurements are formed in fission of target nuclei induced by the neutron flux $\phi(E_n)$ inside of target assemblies. Roughly, the DN spectrum is determined by product of the fission cross section $\sigma_{nf}(E_n)$, the DN multiplicity $\nu_d(E_n)$ and the flux $\phi(E_n)$. For $^{238}\text{U}(n, f)$ reaction the product of $\sigma_{nf}(E_n)\nu_d(E_n)$ varies within several percent over a wide range of E_n , at least, up to 15 MeV. Therefore, the value of $\langle E_n \rangle$ obtained above can be considered as the realistic mean energy of neutrons initiating fission for the studied target assemblies.

The obtained results reflect the difference in the neutron spectra inside the target assemblies «Quinta» and «E + T» tentatively discussed above (just after Fig.4). Of course, the total neutron energy spectrum below 10 MeV should be enriched by prompt fission neutrons produced in initial fission. And with increasing radial target size the role of these secondary neutrons in production of delayed neutrons should become more important. For a quasi-infinite target the value of $\langle E_n \rangle$ should be essentially lower. The value $\langle E_n \rangle$ obtained above gives some indications that, with our intermediate size of the target, most of secondary neutrons leave the target volume without producing fission of target nuclei.

It can be stated that the study of the decay spectra of DN predecessors provides an important and sensitive tool for investigation of basic characteristics of fission process in a massive fissile target used as the active core of an ADS system.

Along with measurements of DN, there were studied the spatial and energy characteristics of the neutron fields inside and on the surface of the target assembly «Quinta» with uranium and lead targets by using the threshold activation detectors. These detectors measured the distributions of the reaction rates for four positions in both targets along the beam axis (see Fig. 1). The neutron energy spectra at the chosen measurement points were reconstructed from these distributions using the standard method of the reference spectrum [29]. Some typical examples of these spectra are shown in Figs. 6 and 7.

Note that the DN contribution in total neutron spectra shown in Figs. 6 and 7 is negligible. These spectra are formed by high-energy neutrons emitted from first fast stages of initial intranuclear cascades (INC) induced by incident deuterons as well as born in secondary INC. Besides, the spectra include secondary neutrons of multiple inelastic scattering and (n, xn) reactions induced by primary neutrons and also by neutrons evaporated from exited residual nuclei of the last stage of INC. An additional and important contribution can go from prompt neutrons of target nucleus fission. But the last contribution depends strongly on the size of multiplying media.

The whole set of neutron spectra were obtained for two distances (3 and 12 cm) from the beam axis and four positions along this axis. The measurement positions for the U and Pb targets were the same. The comparison of these total

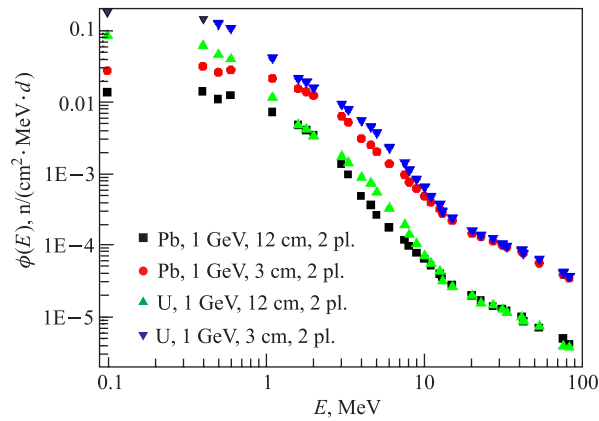

Fig. 6. Neutron energy spectra measured between the first and second target sections at $E_d = 1$ GeV

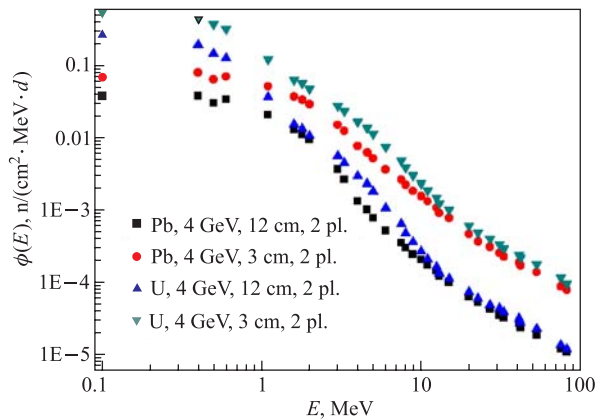

Fig. 7. The same as in Fig. 6 for $E_d = 4$ GeV

neutron spectra partly presented in Figs. 6 and 7 demonstrates the pronounced contribution of prompt fission neutrons in the energy range 1–10 MeV for the uranium target of the «Quinta» assembly.

It can be seen from these figures that the role of prompt fission neutrons is more important for the central zone of the target than for the peripheral regions. Besides, this effect becomes more pronounced with increasing incident deuteron energy. Note that the total neutron multiplicity also grows with increasing deuteron energy. The whole set of neutron spectra will be analyzed in future papers.

3. SCHEMATIC DISCUSSION OF RNT POSSIBILITIES FOR ENERGY PRODUCTION

Draw a conservative assessment of the possibilities of energy production on the basis of RNT. Accept the efficiency of the accelerator equal to 50% and take into account that, in contrast to traditional atomic power plants (APP) where the heat carrier is simultaneously a moderator (that is why their efficiency is limited to $\sim 33\%$), the RNT scheme has an opportunity of using advanced technologies of the 2nd circuit applied today in thermal power plants. In particular, this permits one to realize super critical parameters of water as the heat carrier of the 2nd circuit and to reach an efficiency of $\sim 50\text{--}60\%$. It is also assumed that the heat generated in the active core is lifted by high-temperature helium coolant loop.

A proton accelerator of the power 10 MW ($E_p = 10$ GeV and a current of 1 mA) in accordance with estimates of Table 3, at $BPG \sim 20$ will provide

the starting power of RNT reactor ~ 200 MW. Upon reaching the equilibrium concentration of ^{239}Pu in AC the total energy release can reach values in the range of 1300–2600 MW·h. With an efficiency of the 2nd circuit 50%, the relativistic nuclear power plant (RNPP) at the start will produce 100 MW·h and upon exiting the regime of equilibrium the concentration of ^{239}Pu production could rise to 650–1300 MW·h. Of these, about 20 MW·h will go to its own needs, mainly on the accelerator, since other costs are taken into account in the energy efficiency of the 2nd circuit.

The introduction to the fuel composition of RNPP of a certain percentage of SNF from existing atomic power plants can significantly reduce the time τ_{equil} necessary to reach a steady-state equilibrium concentration of ^{239}Pu due to the presence in SNF of $\sim 2\%$ easily fissioning actinide isotopes [30]. Additionally, the hard neutron spectrum of AC ensures reduction of long-lived activity of the most dangerous components of the downloaded SNF by their transmutation into short-lived isotopes.

In practical application of RNT an important thing is that from the standpoint of physics processes in AC for using SNF in the fuel composition of RNPP there is no necessity for its preliminary radiochemical reprocessing and extraction of long-lived fission fragments and minor actinides.

This opportunity is conditioned by the mechanism of relativistic particle interactions with the AC material. In generation of neutrons in a quasi-infinite AC by means of the intranuclear cascade induced by interaction of high-energy particles with medium nuclei, it is insignificant with light or heavy target nucleus an incident particle is colliding. At the interaction with a light nucleus less spallation neutrons are generated, but they have a much harder spectrum than in the case of interaction with the heavy nucleus. With this in subsequent secondary reactions the effective total multiplicity may increase substantially. (In more detail this mechanism is considered in [6].)

Thus, in RNT for the manufacture of fuel elements of AC one can, in principle, use powdered materials of SNF assemblies (SNFA). In this case, the most appropriate technology will be composed of finely encapsulated materials of SNFAs in the protective power composite shell that prevents the release of fission products in the coolant. Similarly prepared are the main components of fuel from the dioxide of natural (depleted) uranium and/or thorium.

Certainly the development of a «dirty» technology and capacity of production of mechanical and thermal processing of spent fuel and the fabrication of these capsules are required. (Note that some necessary elements of the technology of manufacturing fuel caps have been implemented in the production of MOX-fuel [31] and in development of the micro fuel element (MFE) technology [32].) However, it can be argued that this «dirty» technology will certainly be cleaner than the used and newly developed technologies for processing spent nuclear fuel, both for the open fuel cycle and for the future one [33].

Dimensions of AC of the power plant based on RNT are determined primarily by the fact that the incident beam has to be fully absorbed within AC. It needs the beam way fits at least 5–6 of the free path lengths of its inelastic interactions. This will ensure the total utilization of the beam capacity as well as the realization of the whole «tree» of neutron-production reactions induced in the core by the incident beam. Thus, the main dimensions of AC of the RNT reactor at first approximation do not depend on the generated power, as determined by physical processes in AC.

At present the dimensions of AC of the RNT reactor are supposed to be as follows: diameter ~ 4 m; height ~ 4 m. Taking into account that the beam input windows are embedded deep by ~ 0.5 – 1 m into the volume of AC, the run of the proton beam of an energy of 10 GeV till the exit from AC will be ~ 3 – 3.5 m. At the average density of the spherical MFE grains from the uranium dioxide equal to ~ 5 g/cm³ (obtained with account for collector cavities to realize the helium coolant flow), there will be about seven mean free paths on the 3-meter beam range. This will reduce the beam intensity to a value much smaller than 0.1%.

So in such an AC geometry an energy potential of the beam and the possibilities of multiplication of hard cascade neutrons will be used almost entirely. By using the scanning beam input to the active core, it is possible to expect the density of the proton flux to be less than 10^7 cm⁻² · s⁻¹ at the exit from the AC. Taking into account a thickness of the graphite reflector of ~ 20 cm, the inner diameter and height of the housing of RNT reactor will be ~ 4.5 – 5 m.

The heat generated in AC in operation of power plant based on RNT could be lifted by high-temperature helium coolant. The use of fuel in the form of ball encapsulated MFE filling provides heat exchange surface, a significantly higher proportion of the relevant surface for the case of conventional fuel rods. Due to small size of the fuel capsules ~ 2 – 5 mm, the temperature of MFE kernels exceeds the coolant temperature by more than 30–60°C.

The volume of the RNT reactor core will be about 50 m³, the average density of energy in the development of 2000 MW of thermal (1000 MW electric) power will be 40 kW/l. Preliminary estimates show that the flow of helium coolant to remove such heat output will be ~ 770 kg/s and pressure 16 MPa. The inlet temperature of the helium is $T_{in} = 300^\circ\text{C}$ and the outlet one is $T_{out} = 800^\circ\text{C}$. It is appropriate to note that a design of power plant based on RNT compared to conventional APP should be much simpler, as there is no need for the complicated control and safety systems, and fundamentally safer because AC is operated in a subcritical mode even when the initiating beam is switched in.

CONCLUSION

This paper presents the basic physical and technical principles of the original electronuclear scheme of RNT. It is shown that using RNT one can achieve a significant increase in the power of relativistic particle beam initiating a subcritical

active core. Optimal conditions have been considered for the energy gain in the RNT. First results of experiments conducted at the JINR Nuclotron with model AC indicate the validity of the basic physical principles of RNT. However, further experiments with the greater mass of AC at higher energies of incident particles are required to convincingly justify the application of innovative perspectives of RNT for energy production and utilization of spent nuclear fuel of modern nuclear power plants.

At JINR in the next three years work will be carried out to study the basic properties of RNT under theme 1133, the project «Energy and Transmutation of Radioactive Waste» (see [34]).

Acknowledgements. The authors are grateful to all those who have ensured conduction of the experiments for the project «E&T-RAW» and have participated in the analysis of the results and discussions of the main perspectives of this work, in particular: A. V. Butenko, A. F. Elishev, B. N. Gus'kov, V. D. Kekelidze, E. V. Kostyukhov, A. D. Kovalenko, V. A. Krasnov, M. I. Krivopustov, I. I. Mar'in, G. V. Trubnikov, V. I. Yurevich (VBLHEP, JINR); O. B. Badunov, A. N. Kuznetsov, Yu. N. Kopatch, S. S. Pavlov, N. V. Rebrova, V. N. Shvetsov (FLNP, JINR); V. I. Smirnov (FLNR, JINR); S. N. Berezhnoi, A. S. Egorov, A. A. Goverdovsky, B. V. Keadze, D. N. Kovalev, V. P. Kornilov, V. F. Mitrofanov, G. A. Myakishev, V. M. Piksaikin, V. A. Roschenko, B. F. Samylin (SNC RF IPPE); E. M. Ivanov, F. V. Moroz, G. A. Ryabov, O. A. Scherbakov, L. A. Vaisheine, A. S. Vorobiev (PNPI, RAS); T. N. Korbut (SIP, NAS, Belarus); A. S. Potapenko, A. A. Safronova, I. V. Zhuk (JIP&NR-Sosny, NAS, Belarus); E. P. Maksyakov (CPTP «Atomenergomash»); L. N. Fal'kovsky, B. I. Fonarev (Atomenergomash).

REFERENCES

1. *Barashenkov V. S.* // Part. Nucl. 1978. V. 9, Iss. 5.
2. *Vasil'kov R. G., Goldansky V. I., Orlov V. V.* // Sov. Phys. – Usp. 1983. V. 139, Iss. 3.
3. *Barashenkov V. S.* JINR Preprint P2-94-56. Dubna, 1994.
4. *Nifenecker N. et al.* // Nucl. Instr. Meth. A. 2001. V. 463. P. 428–467.
5. The Problems of Development of Worldwide Nuclear Power and the Relativistic Nuclear Technologies (RNT) (in Russian). <http://www.cftp-aem.ru/Data/RADS02.pdf>.
6. *Galanin M. V. et al.* // Global Safety Problems of Modern Power Production. M., 2006. P. 402–413.
7. *Marchuk G. I.* Numerical Methods of Nuclear Reactor Calculations. M.: Atomizdat, 1958.
8. *Yurevich V. I.* // Part. Nucl. 2009. V. 40. P. 101–135.
9. *Vasil'kov R. et al.* // Atom. Energy. 1978. V. 44, Iss. 4. P. 329.
10. *Barashenkov V. S., Sosnin A. S., Shmakov S. Yu.* JINR Preprint P2-91-122. Dubna, 1991.
11. *Barashenkov V. S., Sosnin A. N., Shmakov S. Yu.* JINR Preprint P2-92-125. Dubna, 1992.

12. *Barashenkov V. S., Sosnin A. N., Shmakov S. Yu.* JINR Preprint P2-92-285. Dubna, 1992.
13. *Gorbachev V. M., Zamyatin Yu. S., Lobov A. A.* Interaction of Radiations with Heavy Nuclei and Nuclear Fission. M.: Atomizdat, 1976.
14. *Gusev E. V., Demchenko P. A., Nikolaichuk L. I.* // VANT, ser. «Plasma Electronics and New Acceleration Methods». 2004. No. 4. P. 27–39.
15. *Walter A., Reynolds A.* Breeding Fast Reactors. M.: Energoatomizdat, 1986 (transl. into Russian).
16. *Yurevich V. I. et al.* // Part. Nucl., Lett. 2006. V. 3. P. 49.
17. *Barashenkov V. S., Toneev V. D.* Interaction of High Energy Particles and Nuclei with Nuclei. M.: Atomizdat, 1972.
18. Relativistic Electro-Nuclear Technologies — a Basis for Developing Wide Scale Nuclear Power (Conceptual Physics and Technical Analysis) (in Russian). <http://www.cftp-aem.ru/Data/RADS01.pdf>.
19. *Andriamonje S. et al.* Experimental Determination of the Energy Generated in Nuclear Cascades by a High Energy Beam // Phys. Lett. B. 1995. V. 348. P. 697.
20. *Furman W. et al.* Time-Dependent Spectra of Neutrons Emitted by Interaction of 1 and 4 GeV Deuterons with Massive Natural Uranium and Lead Targets // Proc. of Intern. Conf. «Nuclear Data for Science and Technology», Jeju island, Korea, 26–29 April 2010, ND1067 (in press).
21. *Gundorin N. A. et al.* // Phys. Atom. Nucl. 2007. V. 70, No. 6. P. 1011–1018.
22. *Dostrovsky I. et al.* Cross Sections for Productions of ^9Li , ^{16}C and ^{17}N in Irradiation with GeV-Energy Protons // Phys. Rev. B. 1965. V. 139. P. 1513.
23. *Krivopustov M. I. et al.* JINR Preprint P1-2000-168. Dubna, 2000; Kerntechnik. 2003. V. 68. P. 48–55.
24. *Waldo R. W. et al.* // Phys. Rev. C. 1981. V. 23. P. 1113.
25. *Tomlinson L.* Delayed Neutrons from Fission. Rep. AERE-R 6993. 1972.
26. *Besant C. B. et al.* Absolute Yields and Group Constants of Delayed Neutrons in Fast Fission of ^{235}U , ^{238}U and ^{239}Pu // J. Br. Nucl. En. Soc. 1977. V. 16. P. 161.
27. *Rose H., Smith R. D.* // J. Nucl. Energy. 1957. V. 4. P. 133.
28. *Isaev S. G.* Study of Delayed Neutrons Parameters in Neutron Induced Fission of Heavy Nuclei. PhD Thesis. IPPE, Obninsk, 2001.
29. *Korneev S. V. et al.* Restoration of Fast Neutron Spectrum in Subcritical Uranium–Lead Assembly of the «Energy plus Transmutation» ADS Installation // Proc. of NAS Belarus, Phys. 2004. V. 1. P. 90–95.
30. *Kolobashkin V. M. et al.* Radiation Characteristics of Irradiated Nuclear Fuel. M.: Energoatomizdat, 1983.
31. Status and Advanced in MOX Fuel Technology. Technical Reports Series no. 415. Vienna: IAEA, 2003.
32. *Sorokin V. V.* Hydraulic and Heat Exchange of Ball Fillings in Conditions of Active Core of LWRs with Micro Fuel Elements. Minsk: Belarus Sci., 2010.
33. *Rachkov V. I. et al.* The Effectivity of Nuclear Power Technology. System Criteria and Development Ways. M.: FGUP «CNII Atominform», 2008.
34. *Adam W. J. et al.* («E&T-RAW» Collaboration). Study of Deep Subcritical Electronuclear Systems and Feasibility of Their Application for Energy Production and Radioactive Waste Transmutation. JINR Preprint E1-2010-61. Dubna, 2010.

Received on March 9, 2011.

Редактор *Е. И. Кравченко*

Подписано в печать 27.04.2011.

Формат 60 × 90/16. Бумага офсетная. Печать офсетная.

Усл. печ. л. 1,25. Уч.-изд. л. 1,74. Тираж 345 экз. Заказ № 57311.

Издательский отдел Объединенного института ядерных исследований
141980, г. Дубна, Московская обл., ул. Жолио-Кюри, 6.

E-mail: publish@jinr.ru

www.jinr.ru/publish/